



	Operating Weight	Max. Reach Ground Level	Rated Power Gross
DX225LL-5	68,784 lb. (31,200 kg)	36' 1" (10,995)	166 hp (124 kW)
DX300LL-5	81,703 lb. (37,060 kg)	38' (11,570)	271 hp (202 kW)
DX380LL-5	113,538 lb. (51,500 kg)	44' 2" (13,474)	318 hp (237 kW)

WHEN YOU CHOOSE DOOSAN

as your heavy equipment brand, you'll have the backing of a strong, global organization – with benefits that extend far beyond the capabilities of a new machine.

DOOSAN



STRONG BRAND

Doosan began in 1896. Its heritage in excavators goes back to 1978. Wheel loader production began in 1992, while the company's first articulated dump truck was designed in 1972. Throughout its years in the heavy equipment industry, Doosan has listened to its North American customers, making many improvements – and developing new machines – as a result of feedback from owners and operators. From 2005 to 2015, Doosan grew from its position as the seventh-largest construction equipment manufacturer in the world to the fifth-largest.

STRONG DEALERS

Doosan serves you in partnership with its dealers – and similarly, your Doosan dealer is intended to be a trusted partner for you. Whether it's Doosan® parts, authorized service and maintenance, or even advice on how to get more value from your machine, Doosan dealers are behind you on every job.

STRONG EQUIPMENT

Doosan products are known for reliably exceeding customers' most demanding expectations. It's why we're one of the fastest-growing heavy equipment brands in North America. Doosan offers crawler excavators, wheel excavators, compact excavators, wheel loaders, articulated dump trucks, log loaders, material handlers and a variety of job-matched attachments – all designed to perform in the most difficult working conditions.

STRONG NORTH AMERICAN OPERATIONS

Doosan has built a solid infrastructure to support your equipment. It includes parts distribution in Illinois and Ontario, service training and product management in Georgia, sales training and The Real Operation Center (ROC) customer experience facility in Arizona, attachment design and development in Minnesota, plus sales and marketing support in North Dakota. We can fully support your equipment from coast to coast.

STRONG WARRANTY

Customers choose the months and hours of coverage in their transferable warranty. Options include a standard warranty of 12 months or up to 1,500 hours (depending on the machine), or up to the five-year, 7,500-hour Elite Assurance™ coverage for the powertrain only, the powertrain plus hydraulics or the full machine.

PERFORMANCE

Doosan takes logging seriously, and we have a strong history of meeting the needs of owners and operators in the challenging timber industry. The result is a lineup of log loaders that are designed specifically for forestry applications, optimized to provide more performance from stump to dump.

Swing Torque

Doosan models have strong and productive swing torque that allows the log loader to swing heavy logs quickly, even when moving the load uphill.

Lifting Capacity

Lift more weight with each cycle and complete the job faster. Doosan log loaders are designed to maximize lifting capability. With an optimal loading reach, loading height and lift position, you can lift and place logs with total confidence.

Selectable Power Modes

Selectable power modes give you more control over your log loader's performance when pioneering a tract, sorting or loading logs. Manage the balance of fuel consumption and machine power to your liking and customize performance to the task.



Power+ mode delivers the fastest workgroup speeds to improve productivity and increase efficiency when loading trucks.



Power mode provides the fastest work group speeds to improve productivity when loading trucks and fast travel speed to save time.



Standard power mode optimizes your fuel consumption and delivers high performance for lifting.



Economy mode reduces fuel consumption for low-demand applications and slows down machine movement, which is handy for jobsite conditions that require extra precision.



More Horsepower

Optimized horsepower gives you better performance for tough forestry applications from shovel logging to sorting and loading.



One-Touch Power Boost

The convenient button on the right-hand joystick provides momentary hydraulic boost when more lifting power is needed. Available on DX300LL-5 and DX225LL-5 models.



PRODUCTIVITY

Fast, powerful and efficient, Doosan log loaders are designed to make every phase of forestry work more productive. It's all about moving more timber per day, and the powerful hydraulic forces, high horsepower and superior torque characteristics of Doosan log loaders easily put better productivity within your reach.



Fast Cycle Times

Two variable-displacement axial piston pumps with regeneration deliver superior hydraulic flow and pressure that maximize cycle times and efficiency. The best-in-class hydraulics deliver ample power to the workgroup and attachment to quickly load trucks.



Auto Idle

The standard auto idle feature automatically idles your engine when machine functions are not used for four seconds. This reduces noise, improves jobsite communications and saves fuel. When you move the controls, the log loader automatically returns to your previous throttle setting.

Auto Shutdown

When auto shutdown is enabled, operators can configure the idle time before the log loader shuts down automatically – from three to 60 minutes – to save valuable fuel for more productive operation.

Auto Downshift

When turning, pushing and maneuvering, auto downshift reduces hydraulic flow to the drive system to improve machine responsiveness and controllability. When the load decreases, the log loader automatically shifts into high range.

Optional Straight Travel Pedal

A straight travel pedal option allows you to travel in a straight line more easily, increasing your efficiency during travel.

Fuel Efficiency

The Doosan log loader's efficient horsepower curve delivers increased torque while using less fuel. Its high pressure common rail (HPCR) fuel injection system aids in reducing emissions and allows the Tier 4-compliant engine to save fuel and improve performance.

Tier 4 (T4) Compliant

Optimized to provide more power output with reduced fuel consumption, Doosan log loaders are designed with T4-compliant engines to reduce air pollution.



Diesel Oxidation Catalyst (DOC)

In the DOC, carbon monoxide (CO) and particulate matter (PM) emissions are transformed into harmless water (H₂O) and carbon dioxide (CO₂).

Evaporative Module

In the evaporative module, or mixing pipe, diesel exhaust fluid (DEF) solution is injected in small doses mixed with hot exhaust gases, decomposing it into urea (CO(NH₂)₂) and water vapor, which then catalyzes into carbon dioxide and ammonia (NH₃).

Selective Catalytic Reduction (SCR)

In the SCR canister, nitrogen oxides mix with ammonia, and a chemical reaction takes place, resulting in nitrogen (N) and water vapor emitting from the system. The SCR canister also acts as the silencer or muffler.

Cooled Exhaust Gas Recirculation (CEGR)

CEGR recycles a portion of the engine exhausts to reduce oxygen (O) and lower the temperature in the combustion chamber. This reduces nitrogen oxide (NO_x) emissions.

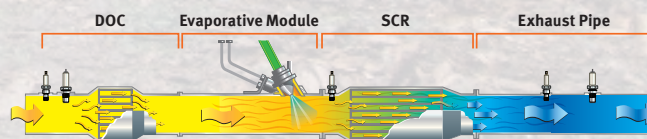

Diesel Exhaust Fluid (DEF)

DEF is a solution of pure urea and deionized water. A minimum level of DEF is required for proper machine operation, and the DEF supply tank is heated for proper operation in cold weather. DEF is available from your Doosan dealer in various container sizes.





One look at a Doosan log loader, and you can tell it's made to withstand the unique challenges of forestry work. They're protected with solid construction and heavy-duty features that keep you running longer – with minimal downtime and fewer service calls.

High-Walker Undercarriage

Doosan log loaders are equipped with a stable, fully guarded, heavy-duty, high and wide undercarriage. Durable top rollers and special cleanout brackets keep you mobile and productive. The tracks feature heavy-duty links with double grouser shoes and full-length track guiding guards. Standard rock guards protect tracks from debris, and an improved front guard further protects log loader components.

Upper Structure

The protected, heavy-duty upper structure is specifically designed for forestry applications such as forwarding, shovel logging, sorting and loading. Cylinder guards protect your boom, arm and heel cylinders from being damaged by debris. The cab guard and guarded cab riser are designed to match the rugged challenges of daily logging.

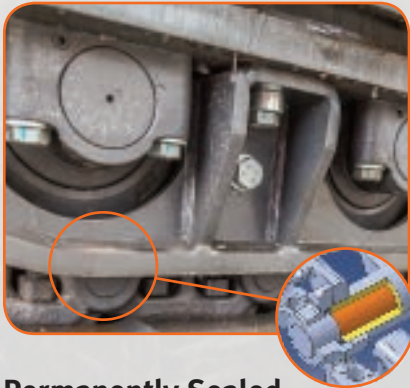

Permanently Sealed, Lubricated Track Pins

Pin links on Doosan log loader tracks are permanently sealed. They never need greasing. That means you reduce your operating costs and increase your uptime.

Air-to-Air Fuel Cooler

The air-to-air fuel cooler reduces fuel temperature to increase your machine's overall efficiency and protect engine components.

Variable Speed Cooling Fan

On the DX300LL-5 and DX380LL-5, the hydraulic oil cooler uses a variable-speed cooling fan. The speed of the fan changes as required by the demands of your log loader. When doing harder work, the fan runs faster for optimized cooling. When you're in lighter duty conditions, the fan runs slower to increase efficiency and reduce noise.

Split Cooling

The split cooling system on the DX300LL-5 and DX380LL-5 allows the oil cooler and radiator to operate independently to ensure optimal hydraulic system and engine temperatures, even in severe working conditions. The system increases cooling capacity while protecting and extending the life of engine components.

Quarter-Inch Side Panels

These thick-skinned log loaders are made to withstand the shocks and impacts encountered on logging jobsites, protecting your machine's vital components for maximum uptime.

Front Cylinder Guarding

A robust guard protects both the boom and arm from the debris and obstacles common in tough logging jobsites.

Front Guard

A front guard further protects log loader components from the debris and obstacles encountered on the job.



COMFORT

An operator can't push performance to the limit if the cabin isn't comfortable. Doosan knows how essential comfort is when clearing timber in remote, unforgiving locations. From its great visibility to its deluxe, adjustable seat, Doosan cabins are easy to enter and exit, and they give you awesome standard features that bring superior comfort to the job.



Other Cabin Features

- Improved floor space for your feet, increased cab space for your legs, arms and head
- 180-degree swinging door
- Wide entry/exit area
- Grab handles and punched panel steps
- Standard radio and antenna with MP3 player input
- 12V power port
- Adjustable side window openings for fresh air

Comfortable Cab

The spacious FOPS cab is fully equipped with operator protection features such as window guarding. Comfort features include heating and air conditioning, with adjustable airflow and five operating modes. The standard reclining, height and weight-adjustable air suspension seat (with headrest, adjustable armrest and seatbelt) offers excellent lumbar support.

Optional Forestry Cab

The optional forestry cab shown here includes additional window guarding, escape hatch, plus heavy-duty latches and hinges to stand up to the challenges of logging. The forestry cab is available with side or rear entry.

Visibility

Sightlines are critical for operator performance, and Doosan log loaders provide the best possible view from inside the cab. The guarded, 4-foot cab riser provides a vantage point over the truck for superior productivity when loading, and the cabin has large front and side windows, narrow corner pillars with small window joints, plus a pillar-mounted wiper. It all gives operators a more unobstructed view. Sun shades on the front and top windows also shield operators from the sun and reduce eye strain. In a Doosan log loader, you can focus on work instead of struggling to see it.

Lighting Options

Optional LED front and rear working lights provide plentiful light before sunrise or after sunset.

Quiet Operation

A complete, sound-isolating cabin seal reduces the noise inside the pressurized cab to an extremely low level. Compartmentalized components reduce noise output outside the cab. Even the cabin frame and seat are designed to absorb vibration and significantly increase operator comfort.

Automotive-Style Heat and Air Conditioning

High-capacity heating and cooling vents, and an easy-to-control temperature, keep you comfortable in every season. Automatic temperature control senses and adjusts to the temperature setting automatically. A memory function returns it to your preferred temperature if you shut the machine off and restart later.

Control Pattern Change Valve

Change the preferred control pattern to match operator preferences.



Standard Rearview Camera

Protect your machine and increase safety with the standard rearview camera. An optional side camera is available, and both cameras can be viewed at once on the LCD panel.



Easy-to-Read LCD Display Panel

An easy-to-read LCD display panel is placed within easy view for monitoring critical machine data, receiving errors or warnings, and viewing the rearview camera display. A big, 7-inch display also switches to a night view.

Adjustable Comfort

The standard air suspension seat has multiple adjustment points, allowing you to select the most comfortable position.

- A Control Stand/Seat Base Fore/Aft
- B Control Stand/Seat Move with Suspension
- C Control Stand/Seat Height
- D Seat Fore/Aft
- E Seat Cushion Fore/Aft
- F Seat Cushion Angle
- G Back Recline
- H Lumbar Support
- I Headrest Fore/Aft and Up/Down
- J Control Stands Up/Down
- K Seat Heater





Even the best equipment needs regular maintenance, but it needs to be as easy as possible when you're working many difficult miles away from your shop or dealership. Doosan simplifies log loader care with onboard diagnostic systems, easy component access and a standard fleet management system. If you want a long-lasting machine that takes minimal effort to keep it running at peak productivity, Doosan delivers everything you need.



Easy Component Access

Access panels are easy to find and open from the top, bottom and sides of the log loader. A large engine bonnet provides plenty of room to reach the top side of the engine, while a hinged belly pan allows access from the bottom. Solid steel side panels provide access to regular daily maintenance items, which makes for quick, easy service and a lower cost of operation.



Centralized Boom Grease Points

Daily maintenance is critical – and it's simple with the centralized grease banks on the base of the boom.



Doosan Telematics
 A simple user interface, accessible online via a web-enabled computer or cellphone, provides location information and a full range of machine operational information to you, your dealer and Doosan, allowing a complete machine maintenance management strategy to reduce operating costs.

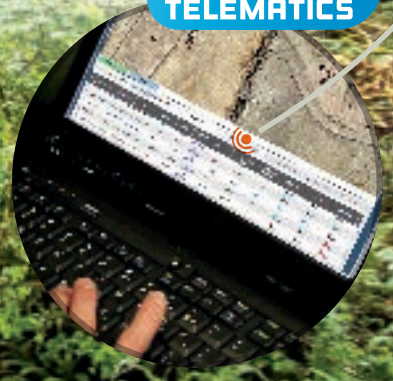

Self-Diagnostics
 The LCD monitor helps you monitor critical systems in real time. Plus, you can access historical machine alerts right from the screen in the cabin.



Doosan Monitoring System with Laptop Access
 The Doosan monitoring system is a diagnostic program that gives your dealer's technician a direct communications link with your log loader. During operation, it monitors all critical data and provides a complete history of operation and a real-time log of machine failures. Armed with information like this, your dealer service personnel can fix issues fast – and you can get back to work.

Auxiliary Mode Switch
 If needed, an auxiliary mode switch allows you to finish a job or move your log loader to a convenient location for service.

Integral Catwalks
 The integral catwalks enable operator access to all critical components and maintenance checks with minimal effort.

Color-Coded, Labeled Wiring
 Wiring in the machine is labeled for easy service, fast troubleshooting and simple installation of electronic accessories – like the rotating beacon.



VERSATILITY

Designed to take on more challenges, from loading and sorting to shovel logging, Doosan log loaders are the most versatile machines in the woods.





Improved Heel Design

The latest heel design on Doosan log loaders works in tandem with a log grapple.

Doosan Log Grapple

Manufactured with T1 steel and hardened components for extreme durability, the Doosan log grapple moves and loads logs easily. Its high-torque rotation motor delivers great productivity and exceptional service life.



- 360-degree continuous rotation improves picking and placing and minimizes the need to move your machine.
- Twin cylinders enable fast jaw articulation and a tight hold on heavy logs.
- Provides an optimal grip range for a variety of log sizes. When fully opened, it easily handles large logs more than 50 inches in diameter, yet it closes to 6 inches for a tight grip on smaller diameter logs.

THE STRENGTH TO PIONEER – DX225LL-5 ROADBUILDER

The DX225LL-5 roadbuilder configuration is designed to excel at the tasks required for pioneering and clearing a new tract, such as clearing felled trees in preparation for building a logging road. Many unique features optimize the roadbuilder configuration to handle this important job.

Stronger Than a Standard Excavator

While the roadbuilder configuration may look similar to your average crawler excavator, the Doosan roadbuilder is designed for tough logging work. It provides excellent ground clearance and superb durability thanks to a fully guarded, durable high and wide undercarriage with heavy-duty track links and full-length track guiding guards.

Traditional Excavator Boom Arm

The excavator style boom and arm provide the optimal working range for traditional pioneering tasks. The machine is typically paired with a quick coupler, bucket and clamp to enhance versatility when removing felled trees and stumps or doing rough grading.

Standard-Height Cab

The cab provides an ideal vantage point for pioneering, offering an excellent view of the work and great all-around visibility. The cab includes all of the comfort features operators need to stay productive and focused on the job.





Coupler Options for Attachment Versatility

Doosan couplers enable you to improve versatility and productivity by utilizing buckets, along with a clamp to tackle the full range of pioneering tasks, such as clearing felled trees, removing stumps, rough grading and site drainage.

Attachment Management

Via the LCD screen, the operator can configure different attachment presets to limit the maximum pressure and the minimum/maximum flow rate delivered to the attachment. Password protection functionality within the system prevents improper attachment preset selection for operators with limited understanding of hydraulic systems.

Wedge Lock Quick Coupler

The versatile wedge lock coupler is an excellent option that allows attachment versatility. Utilize buckets and a clamp to tackle the full range of roadbuilding tasks. The wedge lock coupler provides a limited tip radius increase over pin-on mounting, maintaining optimal maximum breakout force.



Hydraulic “Pin Grabber” Quick Coupler

Save time switching attachments with the hydraulic quick coupler. Utilize buckets or a clamp and complete a variety of roadbuilding tasks. This versatile option allows you to easily hook up your attachments without even leaving the cab.



General

	UNIT	DX225LL-5 Log Loader (US20)	DX300LL-5 Log Loader (US20)	DX380LL-5 LOG LOADER (US20)
ENGINE				
MAKE		Doosan	Scania	Scania
MODEL		DL06P	DC09	DC09
NUMBER OF CYLINDERS		6	5	5
RATED POWER, GROSS (HP PER SAE J1995)	hp (kW) @ rpm	166 (124) @ 1800	271 (202) @ 1800	318 (237) @ 1800
RATED POWER, NET (HP PER SAE J1349)	hp (kW) @ rpm	162 (121) @ 1800	267 (199) @ 1800	313 (233) @ 1800
MAXIMUM TORQUE, GROSS (SAE J1995)	lbf.-ft. (kgf-m) @ rpm	557 (77) @ 1400	940 (130) @ 1300	976 (135) @ 1300
PISTON DISPLACEMENT	in. ³ (L)	359 (5.9)	568 (9.3)	568 (9.3)
BORE AND STROKE	in. x in. (mm x mm)	3.9" x 4.9" (100 x 125)	5.1" x 5.5" (130 x 140)	5.1" x 5.5" (130 x 140)
STARTER	V, hp (kW)	24V, 8.0 (6.0)	24V, 8.0 (6.0)	24V, 8.0 (6.0)
BATTERY (QTY. 2)	V, AH	12V, 150AH	12V, 200AH	12V, 200AH
ALTERNATOR	V, amp	24V, 80A	24V, 100A	24V, 100A
AIR CLEANER		Double Elements	Double Elements	Double Elements
HYDRAULICS				
MAIN PUMPS	gal./min. (L/min.)	2 x 56.4 (2 x 213.5)	2 x 65.5 (2 x 247.9)	2 x 95.1 (2 x 360.0)
PILOT PUMP (GEAR DESIGN)	gal./min. (L/min.)	6.5 (24.7)	7.5 (28.5)	6.3 (24)
RELIEF PRESSURE (NORMAL)	psi (kg/cm ²)	4694 (330.0)	4694 (330.0)	5511 (387.5)
RELIEF PRESSURE (BOOST)	psi (kg/cm ²)	4978 (350.0)	4978 (350.0)	-
MAXIMUM SYSTEM PRESSURE				
BOOM/ARM/BUCKET (NORMAL MODE)	psi (kg/cm ²)	4694 (330.0)	4694 (330.0)	5511 (387.5)
BOOM/ARM/BUCKET (POWER MODE)	psi (kg/cm ²)	4978 (350.0)	4978 (350.0)	-
TRAVEL (NORMAL MODE)	psi (kg/cm ²)	4694 (330.0)	4694 (330.0)	5511 (387.5)
TRAVEL (POWER MODE)	psi (kg/cm ²)	4978 (350.0)	4978 (350.0)	-
SWING (NORMAL MODE)	psi (kg/cm ²)	4694 (330.0)	4694 (330.0)	5511 (387.5)
SWING (POWER MODE)	psi (kg/cm ²)	4978 (350.0)	4978 (350.0)	-
UNDERCARRIAGE				
UPPER ROLLERS (EACH TRACK)		2	2	2
LOWER ROLLERS (EACH TRACK)		9	9	9
NUMBER OF SHOES (LINKS PER SIDE)		45	48	53
TOTAL LENGTH OF TRACK	ft.-in. (mm)	15' 2" (4635)	16' 2" (4920)	18' (5492)
SWING MECHANISM				
SWING SPEED	rpm	0 - 10.2	0 - 9.9	0 - 7.7
SWING TORQUE	lbf.-ft. (kgf-m)	69,623 (9626)	87,787 (12,137)	129,876 (17,956)
DRIVE SYSTEM				
TRAVEL SPEED [LOW - HIGH]	mph (km/h)	1.6 - 2.7 (2.5 - 4.4)	1.9 - 2.9 (3.1 - 4.6)	1.8 - 3.2 (2.9 - 5.2)
TRACTION FORCE (DRAWBAR PULL)	lbf. (kgf)	72,598 (32,930)	70,678 (32,059)	101,673 (46,118)
MAXIMUM GRADE	% (*)	70 (35)	70 (35)	70 (35)
ENVIRONMENT				
SOUND LEVEL (2000/14/EC)	dB(A)	104	104	104
CABIN SOUND LEVEL (ISO 6396)	dB(A)	69	69	69
REFILL CAPACITIES				
FUEL TANK	gal. (L)	266 (1006)	132 (500)	158.5 (600)
DEF TANK	gal. (L)	8.3 (31.5)	18.5 (70.0)	18.5 (70.0)
COOLING SYSTEM (RADIATOR CAPACITY)	gal. (L)	7.9 (30.0)	14.2 (54.0)	14.2 (53.7)
ENGINE OIL	gal. (L)	7.1 (27.0)	9.5 (36.0)	9.5 (36.0)
SWING DRIVE	gal. (L)	1.32 (5.00)	1.85 (7.00)	2.1 (8.00)
FINAL DRIVE (EACH SIDE)	gal. (L)	1.6 (6.00)	1.6 (6.00)	2.6 (10.00)
HYDRAULIC SYSTEM	gal. (L)	74.0 (280.0)	81.9 (310.0)	118.9 (450)
HYDRAULIC TANK	gal. (L)	51.5 (195)	73.9 (280.0)	100 (380.0)

Note: Where applicable, dimensions are in accordance with Society of Automotive Engineers (SAE) and ISO standards. Specifications and design are subject to change without notice.

Pictures of Doosan log loaders may show other than standard equipment. All dimensions are shown in imperial. Respective metric dimensions are enclosed by parentheses.

Doosan equipment is manufactured with a Quality Management System that is in compliance with ISO 9001:2008.

All dimensions are given for Doosan log loaders equipped with standard tracks and the standard front as listed.

Hydraulic Cylinders

	UNIT	DX225LL-5 Log Loader (US20/US25)	DX225LL-5 Road Builder (US30)	DX300LL-5 Log Loader (US20/US25)	DX380LL-5 Log Loader (US20)
BOOM (2)					
BORE x ROD DIAMETER x STROKE	in. x in. x in. (mm x mm x mm)	5.5" x 3.7" x 45" (140 x 95 x 1143)	4.9" x 3.3" x 49.7" (125 x 85 x 1263)	5.9" x 3.9" x 46.9" (150 x 100 x 1190)	6.7" x 4.5" x 52.8" (170 x 115 x 1341)
ARM (1)					
BORE x ROD DIAMETER x STROKE	in. x in. x in. (mm x mm x mm)	6.5" x 4.5" x 55" (165 x 115 x 1396)	5.5" x 3.9" x 57.1" (140 x 100 x 1450)	7.1" x 4.7" x 55.3" (180 x 120 x 1405)	7.5" x 5.1" x 64.4" (190 x 130 x 1635)
HEEL (1)					
BORE x ROD DIAMETER x STROKE	in. x in. x in. (mm x mm x mm)	4.5" x 3.0" x 36" (115 x 75 x 915)	-	5.9" x 3.9" x 39.8" (150 x 100 x 1010)	5.9" x 4.1" x 45.3" (150 x 105 x 1150)
BUCKET (1)					
BORE x ROD DIAMETER x STROKE	in. x in. x in. (mm x mm x mm)	-	4.7" x 3.1" x 41.7" (120 x 80 x 1060)	-	-

The piston rods and cylinder bodies are made of high-strength steel. A shock absorbing mechanism is fitted in all cylinders to ensure shock-free operation and extended piston life.

Weight

DX225LL-5

	UNIT	Standard Cab Log Loader (US20)	Forestry Cab Log Loader (US25)	Standard Cab Road Builder (US30)
SHOE SIZE in. (mm)		2' 4" (700)	2' 4" (700)	2' 4" (700)
COUNTERWEIGHT lb. (kg)		9700 (4400)	9700 (4400)	9700 (4400)
TRACK TYPE		HIGH & WIDE FIXED	HIGH & WIDE FIXED	HIGH & WIDE FIXED
UNIT				
OPERATING WEIGHT	lb. (kg)	68,784 (31,200)	70,548 (32,000)	63,714 (28,900)
GROUND PRESSURE	psi (kgf/cm ²)	8.0 (0.56)	8.1 (0.57)	7.4 (0.52)

DX300LL-5

	UNIT	Standard Cab Log Loader (US20)	Forestry Cab Log Loader (US25)
SHOE SIZE in. (mm)		2' 4" (700)	2' 4" (700)
COUNTERWEIGHT lb. (kg)		13,889 (6300)	13,889 (6300)
TRACK TYPE		HIGH & WIDE FIXED	HIGH & WIDE FIXED
UNIT			
OPERATING WEIGHT	lb. (kg)	81,703 (37,060)	83,577 (37,910)
GROUND PRESSURE	psi (kgf/cm ²)	8.5 (0.60)	9.0 (0.63)

DX380LL-5

	UNIT	Forestry Cab Log Loader (US20)
SHOE SIZE in. (mm)		2' 4" (700)
COUNTERWEIGHT lb. (kg)		18,739 (8500)
TRACK TYPE		HIGH & WIDE FIXED
UNIT		
OPERATING WEIGHT	lb. (kg)	113,538 (51,500)
GROUND PRESSURE	psi (kgf/cm ²)	13.0 (.088)

Specifications

Buckets

DX225LL-5
ROAD BUILDER

	Road Builder (US30)	
BOOM ft.-in. (mm)	18' 8" (5700)	
ARM ft.-in. (mm)	9' 6" (2900)	
SHOE SIZE in. (mm)	2' 4" (700)	
TRACK TYPE	HIGH & WIDE FIXED	
MOUNT	PIN-ON	QUICK COUPLER

BUCKET TYPE	MODEL	CAPACITY ¹ yd ³ (m ³)	WIDTH ft.-in. (mm)	WEIGHT lb. (kg)		
HEAVY DUTY ^{2,3}	HF50-024	0.59 (.045)	26 (660)	1277 (579)	A	A
	HF50-030	0.78 (.060)	32 (813)	1466 (665)	A	A
	HF50-036	0.99 (.076)	38 (965)	1665 (755)	A	A
	HF50-042	1.20 (0.92)	44 (1118)	1820 (826)	A	A
	HF50-048	1.41 (1.08)	50 (1270)	1976 (896)	A	A
DITCHING ⁴	B33B48	0.93 (.071)	48 (1219)	903 (410)	A	A
	B33B60	.098 (0.75)	60 (1524)	1307 (593)	A	A
	B33B72	1.20 (0.92)	72 (1829)	1499 (680)	A	A
HEAVY DUTY DITCHING	H25BW1500	1.92 (1.47)	60 (1500)	2213 (1004)	*	*
	H25BW1700	2.22 (1.70)	67 (1700)	2441 (1107)	*	*
	LP25BW1850	1.67 (1.28)	73 (1850)	2153 (977)	*	*

Grapples

			LGX225	LGX300	LGX380
APPROVED MACHINE			DX225LL-5	DX300LL-5	DX380LL-5
WEIGHT		lb. (kg)	2380 (1079)	2540 (1152)	3460 (1569)
HEIGHT	A	ft.-in. (mm)	7' 2" (2197)	7' 7" (2315)	8' 10" (2699)
WIDTH	B	ft.-in. (mm)	1' 4" (413)	1' 4" (413)	1' 5" (425)
OPEN	C	ft.-in. (mm)	4' 4" (1327)	4' 10" (1480)	5' 3" (1600)
CLOSED	D	ft.-in. (mm)	6.0" (152)	6.0" (152)	6.0" (152)
ROTATION		rpm @ gal./min. (L/min.)	10 @ 4 (15)	10 @ 4 (15)	10 @ 4 (15)

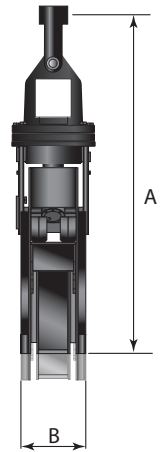

- | | |
|--------------------------------------|--|
| 1 Capacity based on ISO 7451 | Maximum Suitable Material Density |
| 2 Equipped with Side Cutters | A 3370 lb./yd ³ (2000 kg/m ³) |
| 3 Equipped with Bolt On Teeth | B 2700 lb./yd ³ (1600 kg/m ³) |
| 4 Equipped with Bolt On Cutting Edge | C 1850 lb./yd ³ (1100 kg/m ³) |
| | X Not Approved |

*Based on designed use,
not material capacity.

Standard/Optional Equipment

- Standard Equipment
- Optional Equipment
- N/A

	DX225LL-5	DX300LL-5	DX380LL-5
ENGINE			
Emissions (EPA)	T4	T4	T4
High Pressure Common Rail (HPCR)	•	•	•
Turbo, Variable Geometry (VGT)	-	•	•
Turbo, Waste Gate (WGT)	•	-	-
Cooled Exhaust Gas Recirculation (CEGR)	•	•	•
Diesel Oxidation Catalyst (DOC)	•	•	•
Exhaust Brake	-	•	•
Selective Catalyst Reduction (SCR)	•	•	•
Diesel Exhaust Fluid (DEF)	•	•	•
Fuel Filter with Water Separator	•	•	•
Coolant Recovery tank	•	•	•
Dual Element Dry-Type Air Filter with Evacuator	•	•	•
Pre-Cleaner	•	•	•
Electronic Engine Control (ECU)	•	•	•
Auto-Idle	•	•	•
Auto-Shutdown (Time-Adjustable)	•	•	•
Overheat and Low Oil Pressure Engine Protection	•	•	•
Block Heater (110V)	■	■	■
Diesel Powered Coolant Heater	■	■	■
Fuel Filler Pump	■	■	■
HYDRAULIC			
Electronic Power Optimizing System (EPOS)	•	•	•
Bent Axis Piston Main Pump (Tandem)	-	-	•
Variable Axial Piston Main Pump (Tandem)	•	•	-
Cross Sensing Pump Control	•	•	•
Pilot Operated Control Valves	•	•	•
Gear Pilot Pump	•	•	•
D-ECOPOWER	-	-	•
Smart Power Control (SPC)	•*	-	-
Variable Speed Hydraulic Cooling Fan	-	•	•
Axial Piston Swing Motor	•	•	•
Spring Applied Hydraulic Release Brake	•	•	•
Axial Piston Travel Motor (High/Low, Auto)	•	•	•
Auxiliary Hydraulics, Two-Way	•	•	•
Auxiliary Hydraulics, Rotate	•	•	•
Adjustable Auxiliary Flow and Pressure, 10 Presets	•*	-	-
CABIN			
Steel, All-Weather and Sound Suppressed	•	•	-
Cab Riser	•••	•	•
Forestry Cab, Side Entry	■••	■	•
Forestry Cab, Rear Entry	■••	■	■
Cab Guard – Front, Top and Rear	•	•	-
ROPS (ISO 12117-2:2008)	•*	-	-
ROPS (ISO 8082:2003, WCB G602)	-	-	•
FOPS (ISO 8083:2006, WCB G608)	-	-	•
Viscous Mount	•	•	•
Front Window with Wiper/Washer	•	•	•
Tinted Safety Glass	•	•	•
Skylight	•	•	•
Visor, Front Window and Skyliht	•	•	-
Pull-Up Type Top Front Window	•	•	-
Removable Lower Front Window with Storage Behind Seat	•	•	-
Adjustable Sliding Side Door Window	•	•	-
Defrost, Front Window	•	•	•
Lockable Doors	•	•	•
Seat			
- Heated	- Adjustable Height and Recline	•	•
- Air Suspension	- Adjustable Fore/Aft	•	•
- 2" (51 mm) Seat Belt	- Adjustable Arm Rests	•	•
3" (76 mm) Seat Belt		■	■
Control Stands		•	•
- Height Adjustable	- Mounted to Seat Base	•	•
Storage for Operator's Manuals		•	•
Fully Automatic HVAC with Ambient Temperature Sensor		•	•
7" Multi-Function LCD		•	•
Cigarette Lighter		•	•
AM/FM Stereo & MP3 Port		•	•
Speakers (2)		•	•
Antenna, Roof Mounted		•	•
Microphone/Speaker		■	■
Emergency Breakout Tool		•	-
Hot/Cold Beverage Compartment		•	•
Power Socket, 12V		•	•
Beverage Holder		•	•
Interior Light		•	•
Coat Hanger		•	-

* = Road Builder Only

** = NA for Road Builder

*** = NA for DX380LL-5

Standard Equipment based on Standard Arm (US20) configuration

	DX225LL-5	DX300LL-5	DX380LL-5
ELECTRICAL			
System Voltage – 24V	•	•	•
Alternator – 24V, 80 Amp	•	-	-
Alternator – 24V, 100 Amp	-	•	•
2 x 12V Batteries, 150 AH Reserve Capacity	•	-	-
2 x 12V Batteries, 200 AH Reserve Capacity	-	•	•
Blade Type Fuse Panel	•	•	•
Main Circuit Breaker	•	•	•
Light, Work (Halogen): Machine (8), Boom (2)	•	•	•
Light, Work (LED)	■	■	■
Hour Meter	•	•	•
Engine Restart Prevention System	•	•	•
Rearview Camera	•	•	•
Sideview Camera	■	■	■
Laptop Service Port	•	•	•
Self-Diagnostics System	•	•	•
Telematics	•	•	•
DISPLAY/MONITOR & WARNINGS			
Buzzer	•	•	•
- Engine Oil Pressure	- Coolant Temperature		
Gauges			
- Fuel Level	- Hydraulic Pump Pressure		
- DEF Level	- ECO		
- Engine Coolant Temperature	- Digital Clock	•	•
- Hydraulic Oil Temperature	- Trip Meter		
- Engine rpm	- Hour Meter		
- Battery Voltage	- Fuel Consumption		
Warning & Indicator Lights			
- Seat Belt	- Fuel Level		
- Error Code	- DEF Level - Low		
- SCR Warning	- Water in Fuel		
- Check Engine	- Battery Charge		
- Engine Oil Pressure	- Work Lights On	•	•
- Engine Pre-Heat Engaged	- Hydraulic Oil Temperature		
- Radiator Coolant Level & Temperature	- Hydraulic Charge Pressure		
- Air Filter	- Hydraulic Pilot Filter		
Travel Alarm		•	•
UNDERCARRIAGE			
High-Walker, High and Wide Fixed Width	•	•	•
Track Guards and Chains with Adjusters	•	•	•
Track Rollers, Upper (2 Each Side)	•	•	•
Track Rollers, Lower (9 Each Side)	•	•	•
In-Shoe Motor Protection	•	•	•
Shoes, Double Grouser – 700 mm	•	•	•
Shoes, Single Grouser – 700 mm	-	-	■
Link, HD Chain	•	•	•
Track Guides, HD Full Length	•	•	•
MAIN FRAME			
HD Mainframe Reinforcement	•	•	•
HD Integrated Catwalks	•	•	•
HD Guarding, Underbody Plating	•	•	•
HD Guarding, Final Drive Motors	•	•	•
HD Guarding, Side Doors – Pump and Radiator Protection	•	•	•
CONTROLS			
Joystick Controls	•	•	•
Pattern Control Change Valve (SAE, ISO)	•	•	•
Joystick Attachment Control			
Switches/Buttons	- Two-way	•	•
- One-way*	- Power Boost ***		
Control Stands			
- Height Adjustable	- Sliding (Fore/Aft)	•	•
Engine Speed Control Dial		•	•
Travel Pedals with Hand Levers		•	•
Switches, Console Mounted			
- Starter (key)	- Work Light	•	•
- Travel Speed selector	- Auxiliary Mode Switch		
Emergency Stop Switch		•	•
Power Mode (P+, P, S, E)		•	•
Work Mode (Digging, Lifting, Breaker, Shear)*		•	-
Smart Power Control (SPC)*		•	-
Jog Dial Display Control		•	•
Wiper Control Panel		•	•
Audio Control Panel		•	•
OTHER			
Centralized Lubrication			
- Boom	- Swing	•	•
- Arm			
Automatic Greasing		-	■
Handrails and Service Platforms		•	•
Skid-Resistant Steps and Service Platforms		•	•
Manuals			
- Operation & Maintenance	- AEM Safety Manual	•	•
- Parts			
Doosan Connect Subscription, 3 Year (Telematics)		•	•
Vandalism Protection	- Anti-Theft Protection (Password)	•	•
- Lockable Panels			
- Lockable Fluid Fill Points			

Dimensions

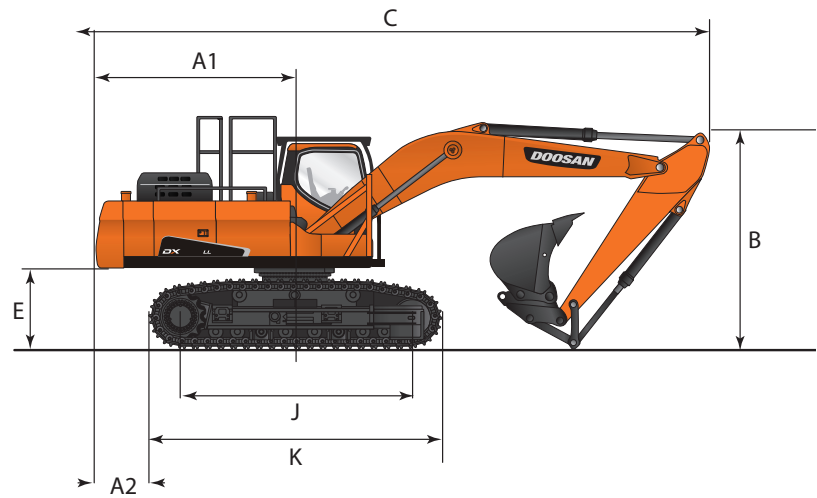
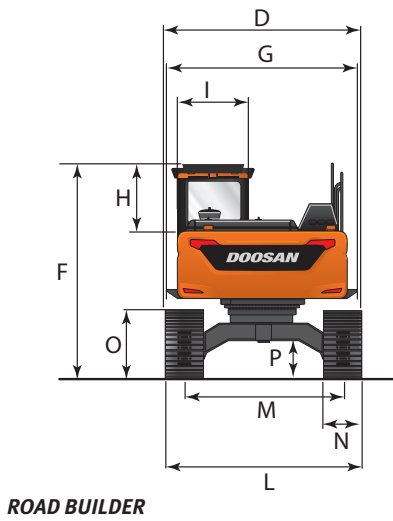

DX225LL-5

			STANDARD CAB Log Loader (US20)	FORESTRY CAB Log Loader (US25)	STANDARD CAB Road Builder (US30)
BOOM		ft.-in. (mm)	20' 2" (6150)		18' 8" (5700)
ARM		ft.-in. (mm)	12' (3657)		9' 6" (2900)
HEEL		ft.-in. (mm)	2' 8" (810)		not configured
BUCKET		yd ³ (m ³)	not configured		1.2 (0.92)
TRACK TYPE			HIGH & WIDE FIXED		HIGH & WIDE FIXED
TAIL SWING RADIUS	A ₁	ft.-in. (mm)	10' 4" (3155)		10' 4" (3155)
TAIL SWING OVERHANG (REAR)	A ₂	ft.-in. (mm)	2' 9" (838)		2' 9" (838)
TAIL SWING OVERHANG (SIDE)	A ₃ *	ft.-in. (mm)	4' 5" (1355)		4' 5" (1355)
SHIPPING HEIGHT	B	ft.-in. (mm)	11' 7" (3530) **		10' 11" (3340) ***
SHIPPING LENGTH	C	ft.-in. (mm)	45' 5" (13,850)		32' 1" (9770)
SHIPPING WIDTH	D	ft.-in. (mm)	11' 10" (3600)		11' 10" (3600)
COUNTERWEIGHT CLEARANCE	E	ft.-in. (mm)	4' 4" (1310)		4' 4" (1310)
CABIN HEIGHT	F	ft.-in. (mm)	15' 2" (4620)	15' 8" (4770)	10' 11" (3340)
CAB RISER	*	ft.-in. (mm)	3' 11" (1200)		not configured
UPPER STRUCTURE WIDTH	G	ft.-in. (mm)	10' 11" (3325)		10' 11" (3325)
CABIN HEIGHT ABOVE HOUSE	H	ft.-in. (mm)	7' 6" (2279)		3' 1" (950)
CABIN WIDTH	I ₁	ft.-in. (mm)	3' 4" (1010)	3' 9" (1140)	3' 4" (1010)
CABIN GAURDING WIDTH	I ₂ *	ft.-in. (mm)	3' 8" (1105)	Std. on forestry cab structure	3' 8" (1105)
TUMBLER DISTANCE	J	ft.-in. (mm)	12' 1" (3680)		12' 1" (3680)
OVERALL TRACK LENGTH	K	ft.-in. (mm)	15' 2" (4635)		15' 2" (4635)
UNDERCARRIAGE WIDTH *Not shown	L	ft.-in. (mm)	11' 10" (3600)		11' 10" (3600)
TRACK GAUGE WIDTH	M	ft.-in. (mm)	9' 6" (2900)		9' 6" (2900)
TRACK SHOE WIDTH	N	ft.-in. (mm)	2' 4" (700)		2' 4" (700)
TRACK HEIGHT	O	ft.-in. (mm)	3' 11" (1204)		3' 11" (1204)
CAR BODY CLEARANCE	P	ft.-in. (mm)	2' 5" (725)		2' 5" (725)
CABIN TILTING ANGLE	*	Degrees	90°		not configured

* Not Shown
 ** Cabin/Riser Lowered
 *** Cabin Height (not Boom)

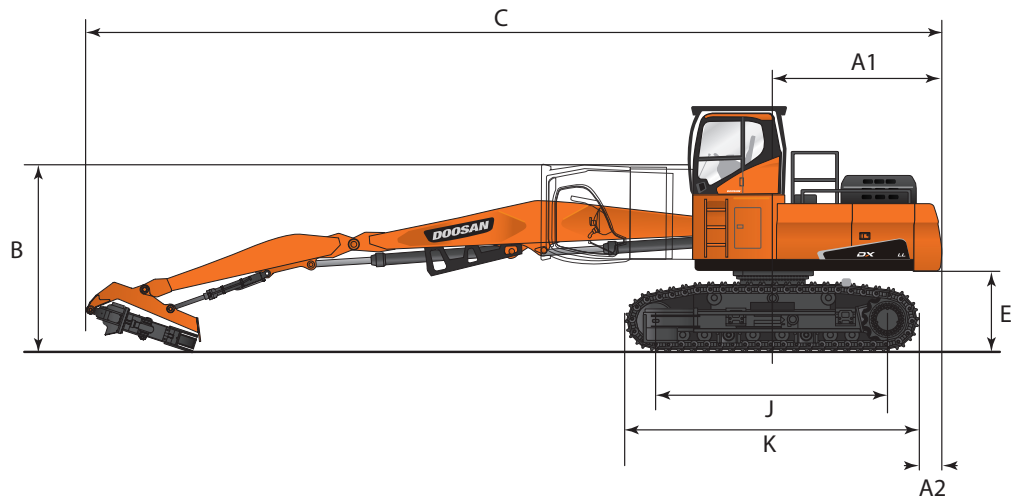
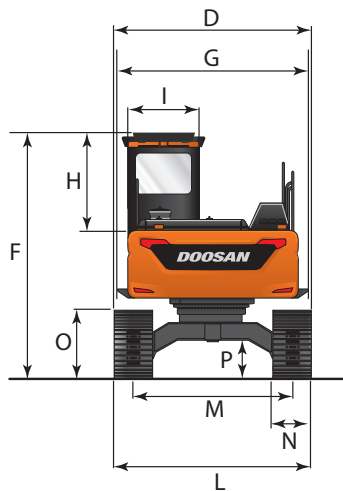

LOG LOADER

Dimensions apply to log loader standard cab and forestry cab configurations.

DX300LL-5

		STANDARD CAB Log Loader (US20)		FORESTRY CAB Log Loader (US25)	
BOOM		ft.-in. (mm)	20' 8" (6300)		
ARM		ft.-in. (mm)	12' 10" (3910)		
HEEL		ft.-in. (mm)	3' 3" (990)		
TRACK TYPE			HIGH & WIDE FIXED		
TAIL SWING RADIUS	A ₁	ft.-in. (mm)	10' 7" (3235)		
TAIL SWING OVERHANG (REAR)	A ₂	ft.-in. (mm)	2' 7" (775)		
TAIL SWING OVERHANG (SIDE)	A ₃ *	ft.-in. (mm)	4' 8" (1435)		
SHIPPING HEIGHT	B	ft.-in. (mm)	11' 9" (3590)		
SHIPPING LENGTH	C	ft.-in. (mm)	47' 5" (14,440)		
SHIPPING WIDTH	D	ft.-in. (mm)	11' 10" (3600)		
COUNTERWEIGHT CLEARANCE	E	ft.-in. (mm)	4' 8" (1420)		
CABIN HEIGHT	F	ft.-in. (mm)	15' 3" (4650)	15' 9" (4799)	
CAB RISER	*	ft.-in. (mm)	3' 11" (1200)		
UPPER STRUCTURE WIDTH	G	ft.-in. (mm)	11' 5" (3480)		
CABIN HEIGHT ABOVE HOUSE	H	ft.-in. (mm)	7' 6" (2279)		
CABIN WIDTH	I ₁	ft.-in. (mm)	3' 4" (1010)	3' 9" (1140)	
CABIN GAURDING WIDTH	I ₂ *	ft.-in. (mm)	3' 8" (1105)	Std. on forestry cab structure	
TUMBLER DISTANCE	J	ft.-in. (mm)	13' 2" (4010)		
OVERALL TRACK LENGTH	K	ft.-in. (mm)	16' 2" (4920)		
UNDERCARRIAGE WIDTH	L	ft.-in. (mm)	11' 10" (3600)		
TRACK GAUGE WIDTH	M	ft.-in. (mm)	9' 6" (2900)		
TRACK SHOE WIDTH	N	ft.-in. (mm)	2' 4" (700)		
TRACK HEIGHT	O	ft.-in. (mm)	4' 1" (1250)		
CAR BODY CLEARANCE	P	ft.-in. (mm)	2' 7" (800)		
CABIN TILTING ANGLE	*	Degrees	90°		

DX380LL-5

		FORESTRY CAB Log Loader (US20)	
BOOM		ft.-in. (mm)	23' 4" (7100)
ARM		ft.-in. (mm)	15' 7" (4750)
HEEL		ft.-in. (mm)	8' 8" (2630)
TRACK TYPE			HIGH & WIDE FIXED
TAIL SWING RADIUS	A ₁	ft.-in. (mm)	11' 7" (3530)
TAIL SWING OVERHANG (REAR)	A ₂	ft.-in. (mm)	2' 7" (784)
TAIL SWING OVERHANG (SIDE)	A ₃ *	ft.-in. (mm)	5' 7" (1710)
SHIPPING HEIGHT	B	ft.-in. (mm)	11' 6" (3515)
SHIPPING LENGTH	C	ft.-in. (mm)	55' (16,755)
SHIPPING WIDTH	D	ft.-in. (mm)	11' 11" (3640)
COUNTERWEIGHT CLEARANCE	E	ft.-in. (mm)	4' 8" (1432)
CABIN HEIGHT	F	ft.-in. (mm)	15' 7" (4756)
CAB RISER	*	ft.-in. (mm)	3' 11" (1200)
UPPER STRUCTURE WIDTH	G	ft.-in. (mm)	11' 10" (3606)
CABIN HEIGHT ABOVE HOUSE	H	ft.-in. (mm)	7' 10" (2379)
CABIN WIDTH	I ₁	ft.-in. (mm)	3' 9" (1140)
CABIN GAURDING WIDTH	I ₂ *	ft.-in. (mm)	Std. on Forestry Cab Structure
TUMBLER DISTANCE	J	ft.-in. (mm)	14' 8" (4475)
OVERALL TRACK LENGTH	K	ft.-in. (mm)	18' (5492)
UNDERCARRIAGE WIDTH	L	ft.-in. (mm)	11' 11" (3640)
TRACK GAUGE WIDTH	M	ft.-in. (mm)	9' 8" (2940)
TRACK SHOE WIDTH	N	ft.-in. (mm)	2' 4" (700)
TRACK HEIGHT	O	ft.-in. (mm)	4' 3" (1286)
CAR BODY CLEARANCE	P	ft.-in. (mm)	2' 6" (760)
CABIN TILTING ANGLE	*	Degrees	90°

* Not Shown
 ** Cabin/Riser Lowered
 *** Cabin Height (not Boom)

Working Range

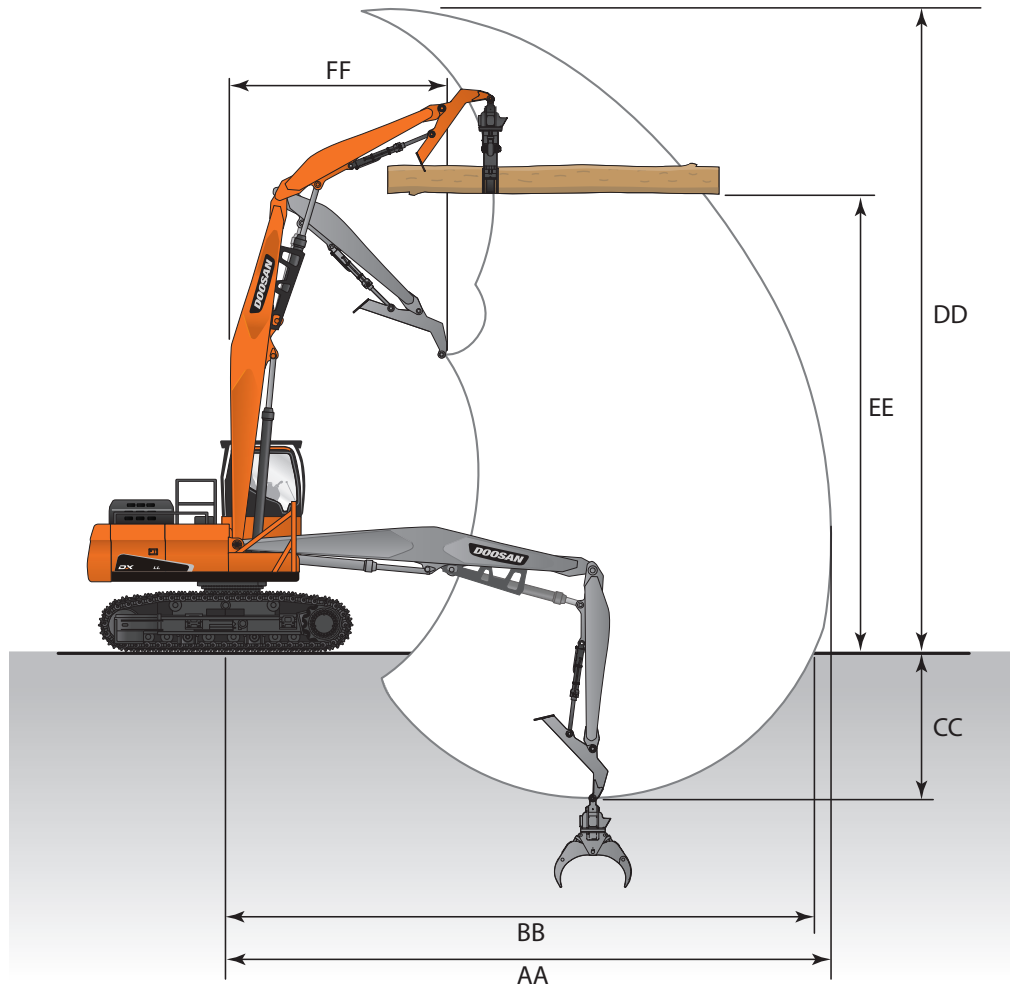

LOG LOADER

			DX225LL-5 Log Loader (US20/US25)	DX300LL-5 Log Loader (US20/US25)	DX380LL-5 Log Loader (US20)
BOOM TYPE		ft.-in. (mm)	20' 2" (6150)	20' 8" (6300)	23' 4" (7100)
ARM TYPE		ft.-in. (mm)	12' (3657)	12' 10" (3910)	15' 7" (4750)
TRACK TYPE			HIGH & WIDE FIXED	HIGH & WIDE FIXED	HIGH & WIDE FIXED
MAX. REACH	AA	ft.-in. (mm)	36' 1" (10,995)	38' (11,570)	44' 2" (13,474)
MAX. REACH (GROUND)	BB	ft.-in. (mm)	35' 5" (10,795)	37' 2" (11,330)	43' 4" (13,212)
MAX. DEPTH	CC	ft.-in. (mm)	11' 4" (3445)	12' 3" (3740)	13' 8" (4157)
MAX. HEIGHT	DD	ft.-in. (mm)	42' 2" (12,860)	43' 1" (13,135)	49' 2" (14,974)
MAX. LEVEL LOG*	EE	ft.-in. (mm)	27' 3" (8305)	28' 7" (8715)	38' 6" (11,729)
MIN. SWING RADIUS	FF	ft.-in. (mm)	12' 2" (3700)	14' 7" (4450)	15' 7" (4750)

* Measured to bottom of log with a diameter of 24" (610 mm)

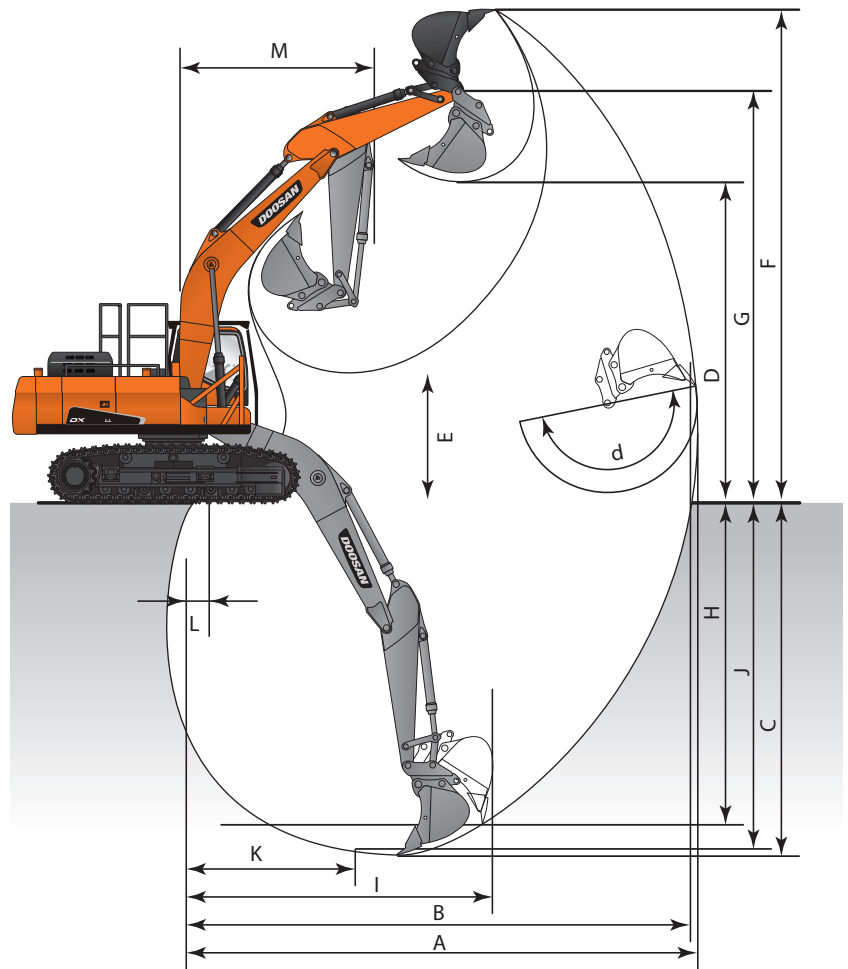

ROAD BUILDER

DX225LL-5
Road Builder (US30)

BOOM TYPE		ft.-in. (mm)	18' 8" (5700)
ARM TYPE		ft.-in. (mm)	9' 6" (2900)
TRACK TYPE			HIGH & WIDE FIXED
MAX. DIGGING REACH	A	ft.-in. (mm)	32' 5" (9880)
MAX. DIGGING REACH (GROUND)	B	ft.-in. (mm)	31' 8" (9660)
MAX. DIGGING DEPTH	C	ft.-in. (mm)	20' 11" (6375)
MAX. LOADING HEIGHT	D	ft.-in. (mm)	23' 1" (7045)
MIN. LOADING HEIGHT	E	ft.-in. (mm)	8' 10" (2705)
MAX. DIGGING HEIGHT	F	ft.-in. (mm)	32' (9760)
MAX. BUCKET PIN HEIGHT	G	ft.-in. (mm)	27' 11" (8500)
MAX. VERTICAL WALL DEPTH	H	ft.-in. (mm)	17' 9" (5410)
MAX. RADIUS VERTICAL	I	ft.-in. (mm)	20' 11" (6380)
MAX. DEPTH TO 8' LINE	J	ft.-in. (mm)	20' 4" (6185)
MIN. RADIUS 8' LINE	K	ft.-in. (mm)	9' 3" (2820)
MIN. DIGGING REACH	L	ft.-in. (mm)	11.6" (295.0)
MIN. SWING RADIUS	M	ft.-in. (mm)	11' 8" (3560)
BUCKET ANGLE (DEG.)	d	Degrees	177°
DIGGING FORCE, BUCKET	*	lbf. (kgf)	33,497 (15,194)
DIGGING FORCE, ARM	*	lbf. (kgf)	23,830 (10,809)

* Not Shown

Lifting Capacity

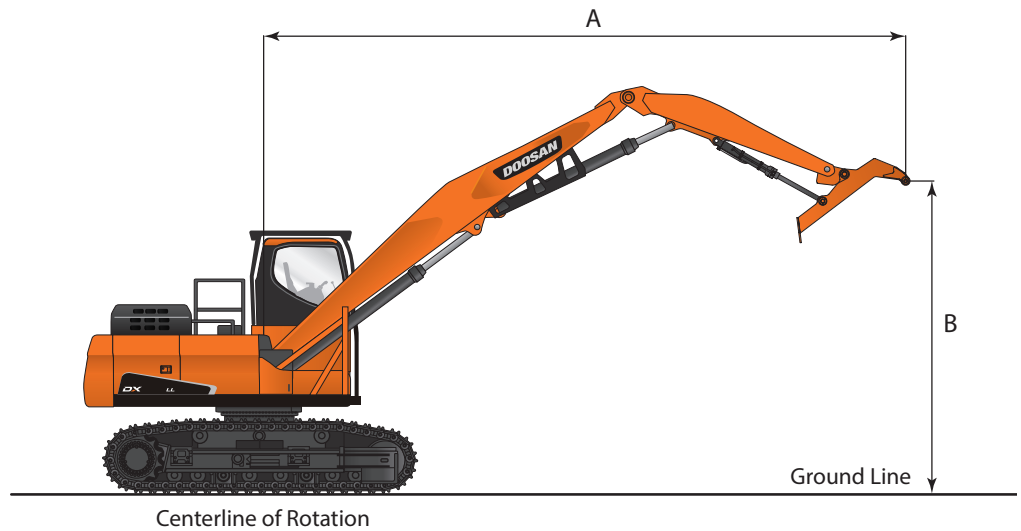

LOG LOADER

DX225LL-5 Standard Cab - Log Loader (US20)

Track Width:	11' 10" (3600 mm)	Grapple:	None	Load Radius Over Front Load Radius Over Side
Boom:	20' 2" (6150 mm)	Shoe Width:	2' 4" (700 mm)	
Arm:	12' (3657 mm)	Counter Weight:	9700 lb. (4400 kg)	
			Unit:	1000 lb. (1000 kg)

B (ft.) \ A (ft.)	10		15		20		25		30		35		MAX REACH		A (ft.)
40													31.95 *	31.95 *	6.44
35			21.19 *	21.19 *	18.69 *	18.69 *							15.10 *	15.10 *	19.79
30					17.41 *	17.41 *	15.88 *	15.12					11.99 *	11.99 *	26.5
25					17.30 *	17.30 *	15.55 *	15.27	13.85	11.17			10.72 *	10.38	30.66
20					18.06 *	18.06 *	15.85 *	15.12	13.88	11.21			10.13 *	9.04	33.33
15			23.97 *	23.97 *	19.49 *	19.49 *	16.50 *	14.77	13.73	11.06	10.66	8.54	9.93 *	8.33	34.9
10			27.68 *	27.68 *	21.16 *	20.1	17.24 *	14.3	13.48	10.82	10.6	8.48	10.03 *	8.04	35.54
5			30.37 *	29.71	22.36 *	19.18	17.34	13.82	13.22	10.57	10.51	8.39	9.57 *	8.06	35.34
0 (GROUND)			30.37 *	28.4	22.36 *	18.48	16.93	13.43	13.01	10.37	9.63 *	8.34	8.41 *	8.34	34.51
-5	13.86 *	13.86 *	27.45 *	27.45 *	20.68 *	18.09	15.93 *	13.2	11.99 *	10.27			8.98 *	8.98 *	32.63
-10			21.90 *	21.90 *	17.03 *	17.03 *	12.85 *	12.85 *					11.62 *	11.62 *	26.09

B (m) \ A (m)	3		4.5		6		7.5		9		10.5		MAX REACH		A (m)
12													14.49 *	14.49 *	1.96
10.5			9.61 *	9.61 *	8.48 *	8.48 *							6.85 *	6.85 *	6.03
9					7.90 *	7.90 *	7.20 *	6.86					5.44 *	5.44 *	8.08
7.5					7.85 *	7.85 *	7.06 *	6.92	6.28	5.07			4.86 *	4.71	9.35
6					8.19 *	8.19 *	7.19 *	6.86	6.3	5.08			4.60 *	4.1	10.16
4.5			10.87 *	10.87 *	8.84 *	8.84 *	7.49 *	6.7	6.23	5.02	4.83	3.87	4.50 *	3.78	10.64
3			12.56 *	12.56 *	9.60 *	9.12	7.82 *	6.49	6.12	4.91	4.81	3.85	4.55 *	3.65	10.83
1.5			13.77 *	13.48	10.14 *	8.7	7.87	6.27	6	4.79	4.77	3.81	4.34 *	3.66	10.77
0 (GROUND)			13.77 *	12.88	10.14 *	8.38	7.68	6.09	5.9	4.7	4.37 *	3.78	3.81 *	3.78	10.52
-1.5	6.28 *	6.28 *	12.45 *	12.45 *	9.38 *	8.2	7.23 *	5.99	5.44 *	4.66			4.07 *	4.07 *	9.94
-3			9.93 *	9.93 *	7.73 *	7.73 *	5.83 *	5.83 *					5.27 *	5.27 *	7.95

* Hydraulically Limited

- Load point is the end of the arm.
- Capacities marked with an asterisk (*) are limited by hydraulic capacities.
- Lift capacities shown do not exceed 75% of minimum tipping loads or 87% of hydraulic capacities.
- The least stable position is over the side.
- The total mass of machine includes the mass of the boom, arm, heel, counterweight, all operating fluids and 165 lb (75 kg) operator.
- Lift capacities are in compliance with ISO 10567.

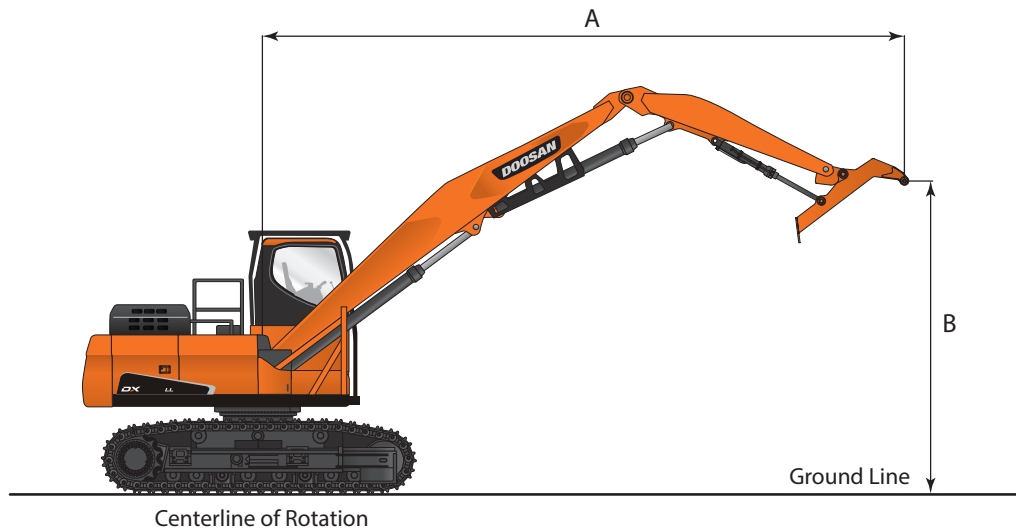

LOG LOADER

DX225LL-5 Forestry Cab - Log Loader (US25)

Track Width:	11' 10" (3600 mm)	Bucket:	None	Load Radius Over Front Load Radius Over Side
Boom:	20' 2" (6150 mm)	Shoe Width:	2' 4" (700 mm)	
Arm:	12' (3657 mm)	Counter Weight:	9700 lb. (4400 kg)	
			Unit:	1000 lb. (1000 kg)

Feet

A (ft.) \ B (ft.)	10		15		20		25		30		35		MAX REACH		A (ft.)
40													31.95 *	31.95 *	6.44
35			21.19 *	21.19 *	18.69 *	18.69 *							15.10 *	15.10 *	19.79
30					17.41 *	17.41 *	15.88 *	15.43					11.99 *	11.99 *	26.5
25					17.30 *	17.30 *	15.55 *	15.55 *	14.13 *	11.42			10.72 *	10.61	30.66
20					18.06 *	18.06 *	15.85 *	15.42	14.07 *	11.45			10.13 *	9.25	33.33
15			23.97 *	23.97 *	19.49 *	19.49 *	16.50 *	15.08	14.04	11.3	10.92	8.74	9.93 *	8.53	34.9
10			27.68 *	27.68 *	21.16 *	20.51	17.24 *	14.61	13.79	11.07	10.86	8.69	10.03 *	8.23	35.54
5			30.37 *	30.33	22.36 *	19.59	17.67 *	14.13	13.53	10.82	10.77	8.6	9.57 *	8.26	35.34
0 (GROUND)			30.37 *	29.02	22.36 *	18.89	17.33	13.74	13.32	10.61	9.63 *	8.55	8.41 *	8.41 *	34.51
-5	13.86 *	13.86 *	27.45 *	27.45 *	20.68 *	18.5	15.93 *	13.51	11.99 *	10.51			8.98 *	8.98 *	32.63
-10			21.90 *	21.90 *	17.03 *	17.03 *	12.85 *	12.85 *					11.62 *	11.62 *	26.09

Metric

A (m) \ B (m)	3		4.5		6		7.5		9		10.5		MAX REACH		A (m)
12													14.49 *	14.49 *	1.96
10.5			9.61 *	9.61 *	8.48 *	8.48 *							6.85 *	6.85 *	6.03
9					7.90 *	7.90 *	7.20 *	7					5.44 *	5.44 *	8.08
7.5					7.85 *	7.85 *	7.06 *	7.06 *	6.41 *	5.18			4.86 *	4.81	9.35
6					8.19 *	8.19 *	7.19 *	7	6.38 *	5.2			4.60 *	4.2	10.16
4.5			10.87 *	10.87 *	8.84 *	8.84 *	7.49 *	6.84	6.37	5.13	4.95	3.96	4.50 *	3.87	10.64
3			12.56 *	12.56 *	9.60 *	9.3	7.82 *	6.63	6.26	5.02	4.93	3.94	4.55 *	3.74	10.83
1.5			13.77 *	13.76	10.14 *	8.89	8.01 *	6.41	6.14	4.91	4.88	3.9	4.34 *	3.75	10.77
0 (GROUND)			13.77 *	13.17	10.14 *	8.57	7.86	6.23	6.04	4.81	4.37 *	3.88	3.81 *	3.81 *	10.52
-1.5	6.28 *	6.28 *	12.45 *	12.45 *	9.38 *	8.39	7.23 *	6.13	5.44 *	4.77			4.07 *	4.07 *	9.94
-3			9.93 *	9.93 *	7.73 *	7.73 *	5.83 *	5.83 *					5.27 *	5.27 *	7.95

* Hydraulically Limited

- Load point is the end of the arm.
- Capacities marked with an asterisk (*) are limited by hydraulic capacities.
- Lift capacities shown do not exceed 75% of minimum tipping loads or 87% of hydraulic capacities.
- The least stable position is over the side.
- The total mass of machine includes the mass of the boom, arm, heel, counterweight, all operating fluids and 165 lb (75 kg) operator.
- Lift capacities are in compliance with ISO 10567.

Lifting Capacity

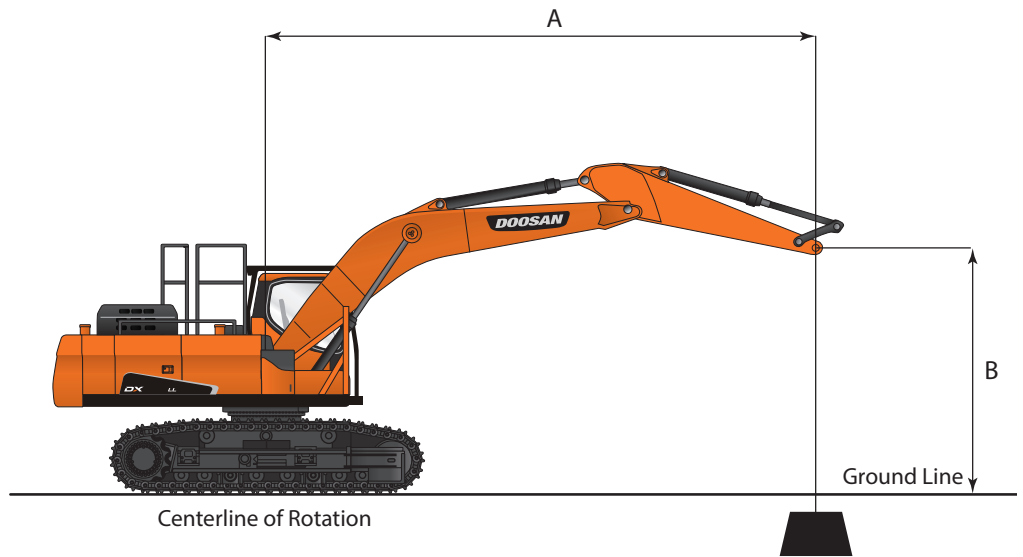



ROAD BUILDER

DX225LL-5 Standard Cab - Road Builder (US30)













Track Width: 11' 10" (3600 mm)
 Boom: 18' 8" (5700 mm)
 Arm: 9' 6" (2900 mm)

Bucket: None
 Shoe Width: 2' 4" (700 mm)
 Counter Weight: 9700 lb. (4400 kg)













Unit: 1000 lb. (1000 kg)

 Load Radius Over Front
 Load Radius Over Side

Feet

B (ft.) \ A (ft.)	5		10		15		20		25		MAX REACH		A (ft.)
													
25							11.77 *	11.77 *			9.28 *	9.28 *	21.03
20							12.03 *	12.03 *			8.74 *	8.74 *	24.43
15					15.72 *	15.72 *	13.33 *	13.33 *	12.18 *	12.18 *	8.68 *	8.68 *	26.47
10					19.79 *	19.79 *	15.20 *	15.20 *	12.97 *	12.97 *	8.96 *	8.96 *	27.48
5					23.14 *	23.14 *	16.94 *	16.94 *	13.80 *	13.80 *	9.61 *	9.61 *	27.58
0 (GROUND)			14.81 *	14.81 *	24.52 *	24.52 *	17.96 *	17.96 *	14.22 *	13.96	10.79 *	10.79 *	26.79
-5	16.25 *	16.25 *	25.05 *	25.05 *	24.02 *	24.02 *	17.83 *	17.83 *	13.63 *		12.96 *	12.96 *	24.99
-10	26.87 *	26.87 *	29.91 *	29.91 *	21.58 *	21.58 *	15.95 *	15.95 *			13.49 *	13.49 *	21.97
-15			21.83 *	21.83 *	15.83 *	15.83 *					12.89 *	12.89 *	17.06

Metric

B (m) \ A (m)	1.5		3		4.5		7.5		6		MAX REACH		A (m)
													
7.5							5.34 *	5.34 *			4.21 *	4.21 *	6.41
6							5.46 *	5.46 *			3.96 *	3.96 *	7.45
4.5					7.13 *	7.13 *	6.05 *	6.05 *	5.52 *	5.52 *	3.94 *	3.94 *	8.07
3					8.98 *	8.98 *	6.89 *	6.89 *	5.88 *	5.88 *	4.06 *	4.06 *	8.38
1.5					10.49 *	10.49 *	7.69 *	7.69 *	6.26 *	6.26 *	4.36 *	4.36 *	8.41
0 (GROUND)			6.72 *	6.72 *	11.12 *	11.12 *	8.14 *	8.14 *	6.45 *	6.33	4.90 *	4.90 *	8.16
-1.5	7.37 *	7.37 *	11.36 *	11.36 *	10.89 *	10.89 *	8.09 *	8.09 *	6.18 *	6.18 *	5.88 *	5.88 *	7.62
-3	12.19 *	12.19 *	13.57 *	13.57 *	9.79 *	9.79 *	7.24 *	7.24 *			6.12 *	6.12 *	6.7
-4.5			9.90 *	9.90 *	7.18 *	7.18 *					5.85 *	5.85 *	5.2

* Hydraulically Limited

- Load point is the end of the arm.
- Capacities marked with an asterisk (*) are limited by hydraulic capacities.
- Lift capacities shown do not exceed 75% of minimum tipping loads or 87% of hydraulic capacities.
- The least stable position is over the side.
- The total mass of machine includes the mass of the boom, arm, heel, counterweight, all operating fluids and 165 lb (75 kg) operator.
- Lift capacities are in compliance with ISO 10567.

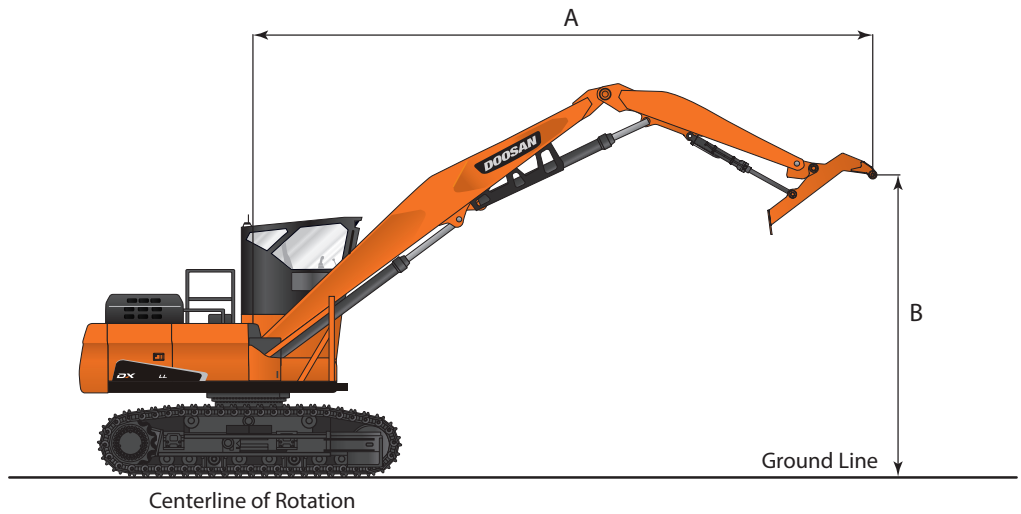

LOG LOADER

DX300LL-5 Standard Cab - Log Loader (US20)

Track Width:	11' 10" (3600 mm)	Grapple:	None	Load Radius Over Front Load Radius Over Side
Boom:	20' 8" (6300 mm)	Shoe Width:	2' 4" (700 mm)	
Arm:	12' 10" (3910 mm)	Counter Weight:	13,889 lb. (6300 kg)	

Feet

B (ft.) \ A (ft.)	10		15		20		25		30		35		MAX REACH		A (ft.)
40													23.94 *	23.94 *	16.01
35													18.19 *	18.19 *	24.2
30							18.86 *	18.86 *	16.74 *	14.3			15.86 *	14.11	29.72
25							18.82 *	18.82 *	17.43 *	14.49			14.85 *	11.73	33.26
20							19.51 *	19.31	17.63 *	14.38	14.96	11.06	14.2	10.48	35.49
15					24.12 *	24.12 *	20.69 *	18.81	18.15 *	14.12	14.88	10.99	13.38	9.83	36.71
10			34.85 *	34.85 *	26.79 *	25.55	22.01 *	18.19	18.68	13.78	14.72	10.84	13.09	9.6	37.06
5			39.24 *	37.85	28.93 *	24.38	23.01 *	17.56	18.31	13.43	14.55	10.67	13.05 *	9.71	36.59
0 (GROUND)			38.22 *	36.21	29.64 *	23.48	23.18 *	17.05	18.01	13.15	14.42	10.55	11.82 *	10.22	35.28
-5	13.08 *	13.08 *	33.56 *	33.56 *	28.36 *	22.98	22.04 *	16.74	17.24 *	12.99	12.06 *	10.55	11.90 *	10.52	34.54
-10			32.17 *	32.17 *	24.71 *	22.85	19.04 *	16.66					14.62 *	13.4	28.89

Metric

B (m) \ A (m)	3		4.5		6		7.5		9		10.5		MAX REACH		A (m)
12													10.86 *	10.86 *	4.88
10.5													8.25 *	8.25 *	7.38
9							8.55 *	8.55 *	7.59 *	6.49			7.20 *	6.4	9.06
7.5							8.54 *	8.54 *	7.91 *	6.57			6.74 *	5.32	10.14
6							8.85 *	8.76	8.00 *	6.52	6.78	5.02	6.44	4.75	10.82
4.5					10.94 *	10.94 *	9.38 *	8.53	8.23 *	6.41	6.75	4.99	6.07	4.46	11.19
3			15.81 *	15.81 *	12.15 *	11.59	9.98 *	8.25	8.47	6.25	6.68	4.92	5.94	4.35	11.3
1.5			17.80 *	17.17	13.12 *	11.06	10.44 *	7.96	8.3	6.09	6.6	4.84	5.92 *	4.41	11.15
0 (GROUND)			17.34 *	16.43	13.44 *	10.65	10.52 *	7.73	8.17	5.96	6.54	4.79	5.36 *	4.63	10.75
-1.5	5.93 *	5.93 *	15.22 *	15.22 *	12.86 *	10.42	10.00 *	7.59	7.82 *	5.89	5.47 *	4.79	5.40 *	4.77	10.53
-3			14.59 *	14.59 *	11.21 *	10.36	8.64 *	7.56					6.63 *	6.08	8.8

* Hydraulically Limited

- Load point is the end of the arm.
- Capacities marked with an asterisk (*) are limited by hydraulic capacities.
- Lift capacities shown do not exceed 75% of minimum tipping loads or 87% of hydraulic capacities.
- The least stable position is over the side.
- The total mass of machine includes the mass of the boom, arm, heel, counterweight, all operating fluids and 165 lb (75 kg) operator.
- Lift capacities are in compliance with ISO 10567.

Lifting Capacity

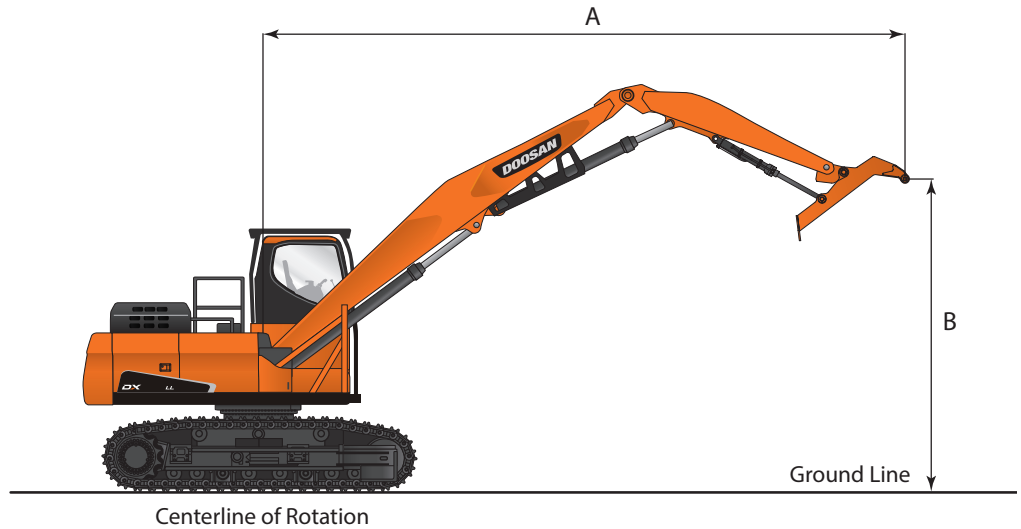

LOG LOADER

DX300LL-5 Forestry Cab - Log Loader (US25)

Track Width:	11' 10" (3600 mm)	Grapple:	None	Load Radius Over Front Load Radius Over Side
Boom:	20' 8" (6300 mm)	Shoe Width:	2' 4" (700 mm)	
Arm:	12' 10" (3910 mm)	Counter Weight:	13,889 lb. (6300 kg)	

Unit: 1000 lb. (1000 kg)

Feet

B (ft.) \ A (ft.)	10		15		20		25		30		35		MAX REACH		A (ft.)
40													23.94 *	23.94 *	16.01
35													18.35 *	18.35 *	23.9
30							18.88 *	18.56	16.38 *	13.45			15.92 *	13.41	29.56
25							18.81 *	18.56	17.43 *	13.65			14.87 *	11.06	33.16
20							19.47 *	18.29	17.62 *	13.56	14.03	10.37	13.35	9.84	35.43
15					24.02 *	24.02 *	20.64 *	17.8	17.93	13.3	13.97	10.31	12.54	9.21	36.68
10			34.63 *	34.63 *	26.69 *	24.2	21.96 *	17.17	17.57	12.96	13.8	10.15	12.25	8.96	37.06
5			39.13 *	35.83	28.87 *	23.02	22.69	16.54	17.2	12.61	13.63	9.99	12.4	9.06	36.62
0 (GROUND)			40.41 *	34.15	29.65 *	22.11	22.13	16.02	16.9	12.33	13.5	9.86	11.88 *	9.51	35.36
-5	16.30 *	16.30 *	36.70 *	33.39	28.45 *	21.59	21.79	15.7	16.72	12.16	12.22 *	9.86	11.84 *	9.77	34.69
-10			32.45 *	32.45 *	24.90 *	21.45	19.20 *	15.62					14.42 *	12.34	29.23

Metric

B (m) \ A (m)	3		4.5		6		7.5		9		10.5		MAX REACH		A (m)
12													10.86 *	10.86 *	4.88
10.5													8.32 *	8.32 *	7.29
9							8.56 *	8.42	7.43 *	6.1			7.22 *	6.08	9.01
7.5							8.53 *	8.42	7.91 *	6.19			6.75 *	5.02	10.11
6							8.83 *	8.3	7.99 *	6.15	6.37	4.7	6.06	4.46	10.8
4.5					10.90 *	10.90 *	9.36 *	8.07	8.13	6.03	6.33	4.68	5.69	4.18	11.18
3			15.71 *	15.71 *	12.11 *	10.98	9.96 *	7.79	7.97	5.88	6.26	4.61	5.55	4.07	11.3
1.5			17.75 *	16.25	13.09 *	10.44	10.29	7.5	7.8	5.72	6.18	4.53	5.62	4.11	11.16
0 (GROUND)			18.33 *	15.49	13.45 *	10.03	10.04	7.27	7.66	5.59	6.12	4.47	5.39 *	4.32	10.78
-1.5	7.39 *	7.39 *	16.65 *	15.14	12.90 *	9.79	9.88	7.12	7.58	5.52	5.54 *	4.47	5.37 *	4.43	10.57
-3			14.72 *	14.72 *	11.29 *	9.73	8.71 *	7.09					6.54 *	5.6	8.91

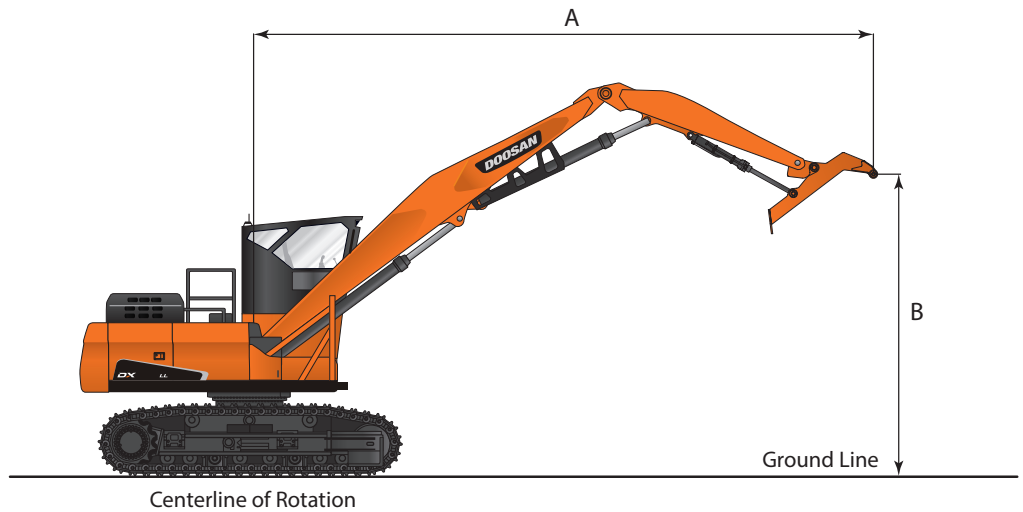

* Hydraulically Limited

- Load point is the end of the arm.
- Capacities marked with an asterisk (*) are limited by hydraulic capacities.
- Lift capacities shown do not exceed 75% of minimum tipping loads or 87% of hydraulic capacities.
- The least stable position is over the side.
- The total mass of machine includes the mass of the boom, arm, heel, counterweight, all operating fluids and 165 lb (75 kg) operator.
- Lift capacities are in compliance with ISO 10567.



















LOG LOADER

















DX380LL-5 Forestry Cab - Log Loader (US20)

Track Width:	11' 11" (3640 mm)	Grapple:	None	 Load Radius Over Front  Load Radius Over Side
Boom:	23' 4" (7100 mm)	Shoe Width:	2' 4" (700 mm)	
Arm:	15' 7" (4750 mm)	Counter Weight:	18,739 lb. (8500 kg)	
		Unit:	1000 lb. (1000 kg)	

Feet

A (ft.) \ B (ft.)	10		15		20		25		30		35		40		MAX REACH		A (ft.)	
																		
45																26.70 *	26.70 *	18.71
40																19.82 *	19.82 *	27.74
35									24.87 *	19.36						17.02 *	14.51	33.67
30									24.82 *	19.53	22.61	14.45				15.63 *	11.7	37.74
25									25.20 *	19.33	22.59	14.44	17.52	10.86		14.93 *	10.11	40.53
20								29.23 *	25.9	26.09 *	18.83	22.31	14.18	17.5	10.84	14.65 *	9.15	42.37
15					30.13 *	30.13 *	31.42 *	24.69	27.30 *	18.1	21.85	13.75	17.29	10.64	14.39	8.61	43.39	
10					41.51 *	33.27	33.77 *	23.24	27.47	17.23	21.28	13.23	16.99	10.36	14.11	8.39	43.67	
5					45.08 *	30.65	35.49	21.77	26.5	16.35	20.71	12.7	16.68	10.07	14.25	8.45	43.24	
0 (GROUND)			29.71 *	29.71 *	46.64 *	28.57	34.11	20.54	25.67	15.6	20.22	12.24	16.42	9.83	14.57	8.65	42.58	
-5	14.25 *	14.25 *	28.91 *	28.91 *	45.50 *	27.28	33.15	19.69	25.08	15.05	19.88	11.92	16.3	9.72	15.62	9.3	40.55	
-10			33.02 *	33.02 *	41.37 *	26.7	32.58 *	19.26	24.78	14.78	19.76	11.81			18.72 *	11.3	35.52	

Metric

A (m) \ B (m)	3		4.5		6		7.5		9		10.5		12		MAX REACH		A (m)	
																		
13.5																12.11 *	12.11 *	5.7
12																8.99 *	8.99 *	8.45
10.5									11.28 *	8.78						7.72 *	6.58	10.26
9									11.26 *	8.86	10.25	6.55				7.09 *	5.31	11.5
7.5									11.43 *	8.77	10.25	6.55	7.95	4.93		6.77 *	4.59	12.35
6							13.26 *	11.75	11.83 *	8.54	10.12	6.43	7.94	4.92		6.65 *	4.15	12.91
4.5					13.67 *	13.67 *	14.25 *	11.2	12.38 *	8.21	9.91	6.24	7.84	4.83		6.53	3.91	13.23
3					18.83 *	15.09	15.32 *	10.54	12.46	7.82	9.65	6	7.71	4.7		6.4	3.8	13.31
1.5					20.45 *	13.9	16.1	9.88	12.02	7.42	9.4	5.76	7.56	4.57		6.46	3.83	13.18
0 (GROUND)			13.47 *	13.47 *	21.15 *	12.96	15.47	9.32	11.64	7.07	9.17	5.55	7.45	4.46		6.61	3.92	12.98
-1.5	6.46 *	6.46 *	13.12 *	13.12 *	20.64 *	12.37	15.04	8.93	11.37	6.83	9.02	5.41	7.39	4.41		7.09	4.22	12.36
-3			14.98 *	14.98 *	18.76 *	12.11	14.78 *	8.73	11.24	6.71	8.96	5.36				8.49 *	5.13	10.83

* Hydraulically Limited

- Load point is the end of the arm.
- Capacities marked with an asterisk (*) are limited by hydraulic capacities.
- Lift capacities shown do not exceed 75% of minimum tipping loads or 87% of hydraulic capacities.
- The least stable position is over the side.
- The total mass of machine includes the mass of the boom, arm, heel, counterweight, all operating fluids and 165 lb (75 kg) operator.
- Lift capacities are in compliance with ISO 10567.



DOOSAN STRONG



Printed on 10% recycled paper

1.877.745.7814
DoosanEquipment.com/LL

Doosan® and the Doosan logo are registered trademarks of Doosan Corp. in the United States and various other countries around the world. ©2018 Doosan Infracore North America, LLC. All rights reserved.

DOOSAN®